

The power behind competitiveness

Delta UPS - Amplon Family

INX Series, Single Phase
1/ 2/ 3 kVA

User Manual

www.deltapowersolutions.com



DELTA
Smarter. Greener. Together.

Save This Manual

This manual contains important instructions and warnings that you should follow during the installation, operation, storage and maintenance of this product. Failure to heed these instructions and warnings will void the warranty.

Copyright © 2018 by Delta Electronics Inc. All Rights Reserved. All rights of this User Manual (“Manual”), including but not limited to the contents, information, and figures are solely owned and reserved by Delta Electronics Inc. (“Delta”). The Manual can only be applied to the operation or the use of this product. Any disposition, duplication, dissemination, reproduction, modification, translation, extraction, or usage of this Manual in whole or in part is prohibited without the prior written permission of Delta. Given that Delta will continuously improve and develop the product, changes may be made to the information in this Manual at any time without obligation to notify any person of such revision or changes. Delta will make all possible efforts to secure the accuracy and the integrity of this Manual. Delta disclaims any kinds or forms of warranty, guarantee, or undertaking, either expressly or implicitly, including but not limited to the completeness, faultlessness, accuracy, non-infringement, merchantability or fitness for a particular purpose of the Manual.

Table of Contents

Chapter 1 : Important Safety Warnings	1
1.1 Transportation	1
1.2 Preparation	1
1.3 Installation	1
1.4 Operation	2
1.5 Maintenance, Service and Faults	2
1.6 Packing List	3
Chapter 2 : Installation and Setup	4
2.1 Rear Panel View	4
2.2 Operating principle	6
2.3 Setup the UPS	6
2.4 Battery Replacement	9
Chapter 3 : Operation	10
3.1 Button Operation	10
3.2 LCD Panel	11
3.3 Audible Alarm	13
3.4 LCD Display Wordings Index	14
3.5 UPS Setting	15
3.6 Operating Mode Description	19
3.7 Faults Reference Code	21
3.8 Warning Indicator	22
Chapter 4 : Troubleshooting	23
Chapter 5 : Storage and Maintenance	25
Chapter 6 : Technical Specifications	26
Chapter 7 : Warranty	28

Chapter 1 : Important Safety Warnings

Please comply with all warnings and operating instructions in this manual strictly. Save this manual properly and read carefully the following instructions before installing the unit. Do not operate this unit before reading through all safety information and operating instructions carefully.

1.1 Transportation

- Please transport the UPS system only in the original package to protect against shock and impact.

1.2 Preparation

- Condensation may occur if the UPS system is moved directly from cold to warm environment. The UPS system must be absolutely dry before being installed. Please allow at least two hours for the UPS system to acclimate the environment.
- Do not install the UPS system near water or in moist environments.
- Do not install the UPS system where it would be exposed to direct sunlight or near heater.
- Do not block ventilation holes in the UPS housing.

1.3 Installation

- Do not connect appliances or devices which would overload the UPS system (e.g. laser printers) to the UPS output sockets.
- Please do not attached half-sinewave load or motor load to the UPS.
- Place cables in such a way that no one can step on or trip over them.
- Do not connect domestic appliances such as hair dryers to the UPS output sockets.
- The UPS can be operated by any individuals with no previous experience.
- Connect the UPS system only to an earthed shockproof outlet which must be easily accessible and close to the UPS system.
- Please use only VDE-tested, CE-marked mains cable (e.g. the mains cable of your computer) to connect the UPS system to the building wiring outlet (shock-

proof outlet).

- Please use only VDE-tested, CE-marked power cables to connect the loads to the UPS system.
- When installing the equipment, it should ensure that the sum of the leakage current of the UPS and the connected devices does not exceed 3.5mA.

1.4 Operation

- Do not disconnect the mains cable on the UPS system or the building wiring outlet (shockproof socket outlet) during operations since this would cancel the protective earthing of the UPS system and of all connected loads.
- The UPS system features its own, internal current source (batteries). The UPS output sockets or output terminals block may be electrically live even if the UPS system is not connected to the building wiring outlet.
- In order to fully disconnect the UPS system, first press the OFF/ ENTER button to disconnect the mains.
- Prevent no fluids or other foreign objects from inside of the UPS system.

1.5 Maintenance, Service and Faults

- The UPS system operates with hazardous voltages. Repairs may be carried out only by qualified maintenance personnel.



WARNING:

Risk of electric shock. Even after the unit is disconnected from the mains (building wiring outlet), components inside the UPS system are still connected to the battery and electrically live and dangerous.

- Before carrying out any kind of service and/ or maintenance, disconnect the batteries and verify that no current is present and no hazardous voltage exists in the terminals of high capability capacitor such as BUS-capacitors.
- Only persons are adequately familiar with batteries and with the required precautionary measures may replace batteries and supervise operations. Unauthorized persons must be kept well away from the batteries.



WARNING:

Risk of electric shock. The battery circuit is not isolated from the input voltage. Hazardous voltages may occur between the battery terminals and the ground. Before touching, please verify that no voltage is present!

- Batteries may cause electric shock and have a high short-circuit current. Please take the precautionary measures specified below and any other measures necessary when working with batteries:
 - remove wristwatches, rings and other metal objects
 - use only tools with insulated grips and handles.
- When changing batteries, install the same number and same type of batteries.
- Do not attempt to dispose of batteries by burning them. This could cause battery explosion.
- Do not open or destroy batteries. Escaping electrolyte can cause injury to the skin and eyes. It may be toxic.
- Please replace the fuse only with the same type and amperage in order to avoid fire hazards.
- Do not dismantle the UPS system.

1.6 Packing List

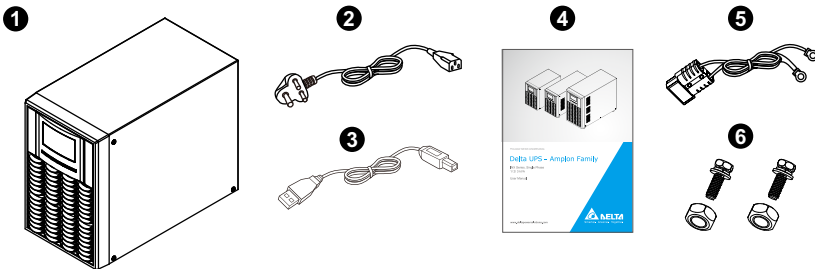

No.	Item	Q'ty
①	UPS	1 PC
②	Input cable	1 PC
③	USB cable	1 PC
④	User manual	1 PC
⑤	Battery cable (for Extended Runtime Model only)	1 PC
⑥	Screws and nuts (for Extended Runtime Model only)	2 Sets

Chapter 2 : Installation and Setup



NOTE:

Before installation, please inspect the unit. Be sure that nothing inside the package is damaged. Please keep the original package in a safe place for future use.

2.1 Rear Panel View

- Standard Runtime Model

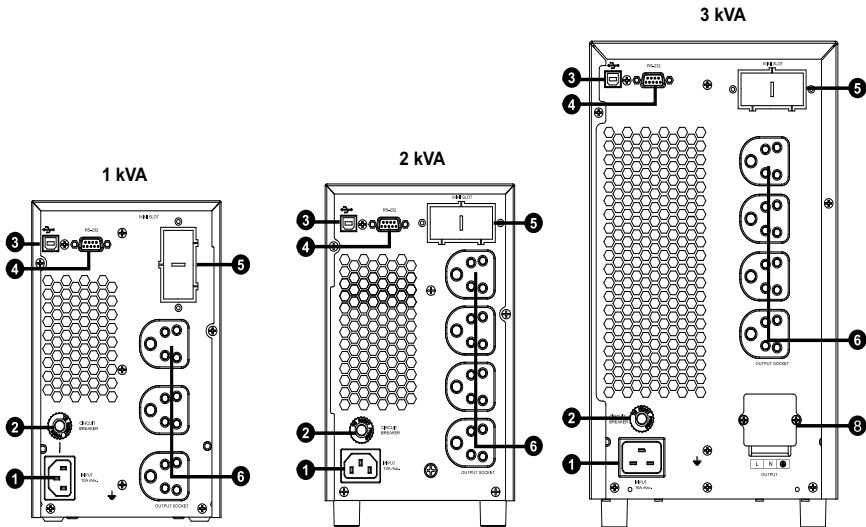

- Extended Runtime Model

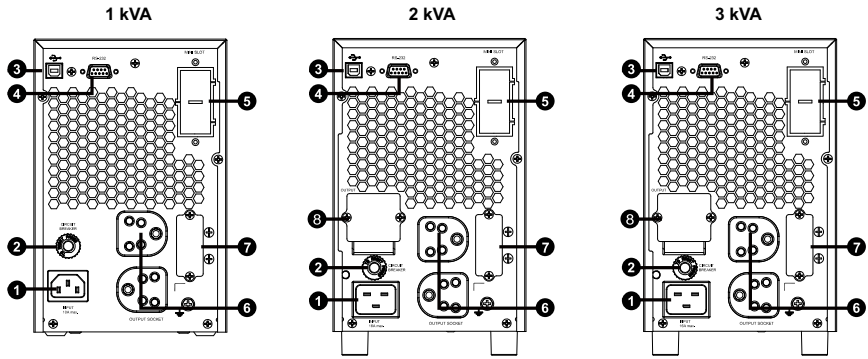

No.	Item
①	AC input
②	Input circuit breaker
③	USB port
④	RS-232 port
⑤	Mini slot
⑥	Output socket
⑦	External battery connector
⑧	Output terminal

2.2 Operating principle

The operating principle of the UPS is shown as below

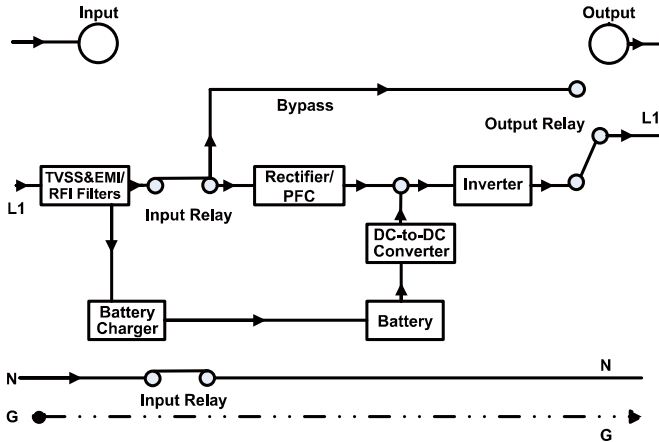

2.3 Setup the UPS

Step 1: Connect battery wires

If UPS is extended runtime model, please connect external batteries as below chart.

Please refer to below chart to secure battery cable to the terminal with supplied screws and nuts.

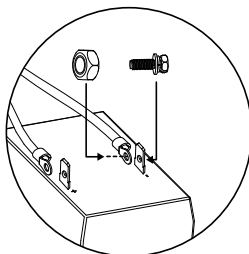
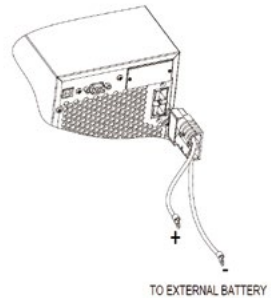

Step 2: UPS input connection

Plug the UPS into a two-pole, three-wire, grounded receptacle only. Avoid using extension cords.

- The power cord is attached to the UPS. For the type of power cord, please refer to the table below.

UPS		Type of Power Cord
Standard Runtime Model	1kVA	Plug 10A INDIA
	2kVA	Plug 10A INDIA
	3kVA	Plug 16A INDIA
Extended Runtime Model	1kVA	Plug 10A INDIA
	2kVA	Plug 16A INDIA
	3kVA	Plug 16A INDIA

Step 3: UPS output connection

- For socket-type outputs, simply connect devices to the outlets.
- For terminal-type outputs, please follow below steps for the wiring configuration:
 1. Remove the small cover of the terminal block
 2. Suggest using AWG12 ~ 10 or 3.3mm² ~ 5.3mm² power cords for 3kVA. Please also install a circuit breaker (40A) between the mains and AC input of the UPS in 3kVA for safety operation.
 3. Upon completion of the wiring configuration, please check whether the wires are securely affixed.
 4. Put the small cover back to the rear panel.

Step 4: Communication connection

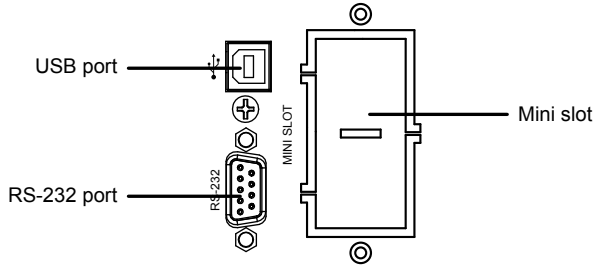

To allow for unattended UPS shutdown/ start-up and status monitoring, connect the communication cable one end to the USB/ RS-232 port and the other to the communication port of your PC. With the monitoring software installed, you can schedule UPS shutdown/ start-up and monitor UPS status through PC.

The UPS is equipped with mini slot perfect for Delta mini SNMP, Relay I/O, Modbus or TVSS cards (optional). When installing mini card in the UPS, it will provide advanced communication and monitoring options.



NOTE:

1. The USB port and RS-232 port can't work at the same time.
2. If you choose to use the USB port rather than RS-232 port, please install the USB driver software in your computer after connecting your computer to the UPS's USB port. The software can be downloaded from <http://www.deltapowersolutions.com/en-in/mcis/1kva-3kva-single-phase-ups-inx-series-downloads.php>.

Step 5: Turn on the UPS

Press the ON/ MUTE button on the front panel for two seconds to power on the UPS.



NOTE:

The battery charges fully during the first five hours of normal operation. Do not expect full battery run capability during this initial charge period.

Step 6: Install software

For optimal computer system protection, install UPS monitoring software to fully configure UPS shutdown. Please download the software from <http://www.deltapowersolutions.com/en/mcis/software-center.php>.

2.4 Battery Replacement



WARNING:

1. This rack UPS is equipped with internal batteries and user can replace the batteries without shutting down the UPS or connected loads (hot-swappable battery design). Replacement is a safe procedure, isolated from electrical hazards.
2. Consider all warnings, cautions, and notes before replacing batteries.



NOTE: Upon battery disconnection, equipment is not protected from power outages.

Chapter 3 : Operation

3.1 Button Operation

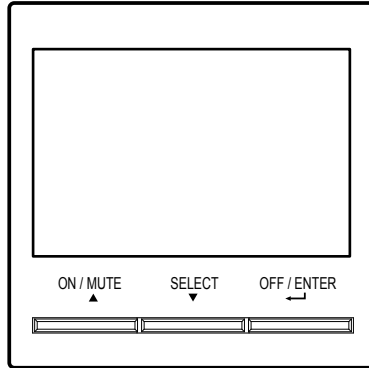







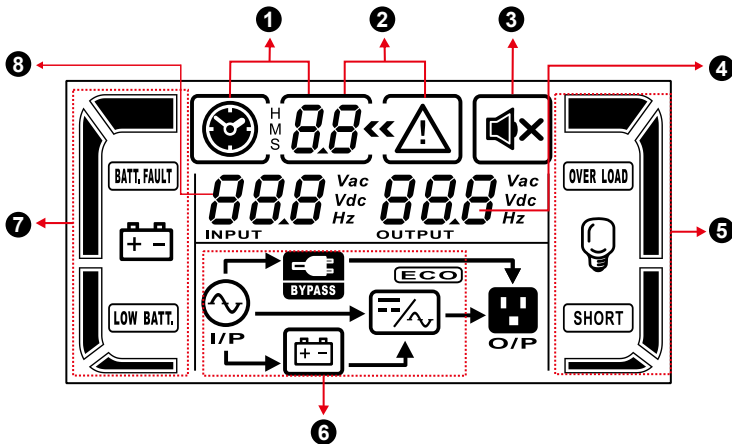











Button	Function
ON/ MUTE Button	<ul style="list-style-type: none"> • Turn on the UPS: Press and hold the ON/ MUTE button for at least 2 seconds to turn on the UPS. • Mute the alarm: When the UPS is in battery mode, press and hold this button for at least 5 seconds to disable or enable the alarm system. But it's not applied to the situations when warnings or errors occur. • Up key: Press this button to display previous selection in UPS setting mode. • Switch to UPS self-test mode: Press and hold this button for 5 seconds to enter UPS self-testing while in AC mode, ECO mode, or converter mode.
OFF/ ENTER Button	<ul style="list-style-type: none"> • Turn off the UPS: Press and hold this button at least 2 seconds to turn off the UPS. The UPS will switch to either standby mode or bypass mode according to your setting of bypass function. If you enable the bypass function, the UPS will transfer to bypass mode; if you disable the bypass function, the UPS will transfer to standby mode without any output. Please refer to 3.5 UPS Setting- 06: Bypass enable/ disable when the UPS is off.

Button	Function
	<ul style="list-style-type: none"> Confirm selection key: Press this button to confirm selection in UPS setting mode.
SELECT Button	<ul style="list-style-type: none"> Switch LCD message: Press this button to change the LCD message for input voltage, input frequency, battery voltage, output voltage and output frequency. It will return back to default display when pausing for 10 seconds. Setting mode: Press and hold this button for 5 seconds to enter UPS setting mode when the UPS is in standby mode or bypass mode. Down key: Press this button to display next selection in UPS setting mode.
ON/ MUTE + SELECT Buttons	<ul style="list-style-type: none"> Switch to bypass mode: When the main power is normal, press the ON/ MUTE and SELECT buttons simultaneously for 5 seconds. Then the UPS will enter to bypass mode. This action will be ineffective when the input voltage is out of acceptable range.

3.2 LCD Panel

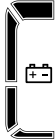

Display	Function
1 Remaining backup time information	
	Indicates the remaining backup time in pie chart.
	Indicates the remaining backup time in numbers. H: hour, M: minute, S: second
2 Fault information	
	Indicates that the warning and fault occurs.
	Indicates the warning and fault codes, and the codes are listed in details in 3.7 UPS Setting .
3 Mute operation	
	Indicates that the UPS alarm is disabled.
4 Output & Battery voltage information	
	Indicates the output voltage, frequency or battery voltage. Vac: output voltage, Vdc: battery voltage, Hz: frequency
5 Load information	
	Indicates the load level by 0-25%, 26-50%, 51-75%, and 76-100%.
	Indicates overload.
	Indicates the load or the UPS output is short circuit.
6 Mode operation information	
	Indicates the UPS connects to the mains.
	Indicates the battery is working.
	Indicates the bypass circuit is working.

Display	Function
	Indicates the ECO mode is enabled.
	Indicates the inverter circuit is working.
	Indicates the output is working.
7 Battery information	
	Indicates the battery level by 0-25%, 26-50%, 51-75%, and 76-100%.
	Indicates the battery is fault.
	Indicates low battery level and low battery voltage.
8 Input & Battery voltage information	
	Indicates the input voltage or frequency or battery voltage. Vac: Input voltage, Vdc: battery voltage, Hz: input frequency

3.3 Audible Alarm

Condition	Alarm
Battery Mode	Sounding every 4 seconds
Low Battery	Sounding every second
Overload	Sounding twice every second
Fault	Continuously sounding
Bypass Mode	Sounding every 10 seconds

3.4 LCD Display Wordings Index

Abbreviation	Display Content	Meaning
ENA	<i>ENR</i>	Enable
DIS	<i>DIS</i>	Disable
ESC	<i>ESC</i>	Escape
HLS	<i>HLS</i>	High loss
LLS	<i>LLS</i>	Low loss
BAT	<i>BAT</i>	Battery
CF	<i>CF</i>	Converter
TP	<i>TP</i>	Temperature
CH	<i>CH</i>	Charger
FU	<i>FU</i>	Bypass frequency unstable
EE	<i>EE</i>	EEPROM error

3.5 UPS Setting

There are three parameters to set up the UPS.

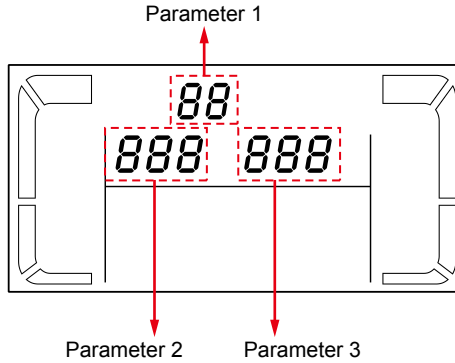

Parameter 1: It's for program alternatives. Refer to below table.

Parameter 2 and **Parameter 3** are the setting options or values for each program.

• 01: Output voltage setting

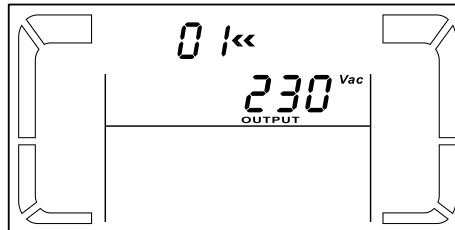

Parameter 3: Output voltage

For 200/208/220/230/240 VAC models, you may choose the following output voltage:

- 200:** presents output voltage is 200Vac
- 208:** presents output voltage is 208Vac
- 220:** presents output voltage is 220Vac
- 230:** presents output voltage is 230Vac (Default)
- 240:** presents output voltage is 240Vac

- **02: Frequency converter enable/ disable**

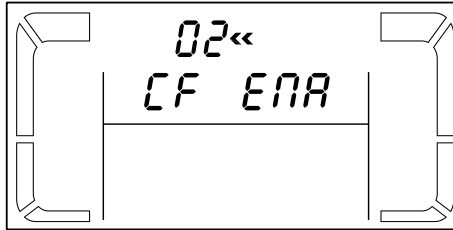

Parameter 2 & 3: Enable or disable converter mode. You may choose the following two options.

CF ENA: converter mode enable

CF DIS: converter mode disable (Default)

- **03: Output frequency setting**

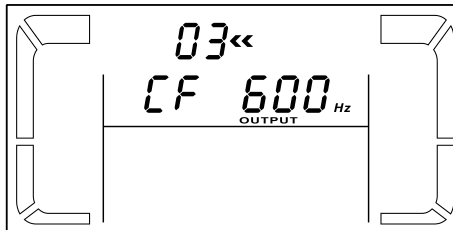

Parameter 2 & 3: Output frequency setting.

You may set the initial frequency in battery mode.

BAT 50: presents output frequency 50Hz

BAT 60: presents output frequency 60Hz

If converter mode is enabled, you may choose the following output frequency.

CF 50: presents output frequency 50Hz

CF 60: presents output frequency 60Hz

- **04: ECO enable/ disable**

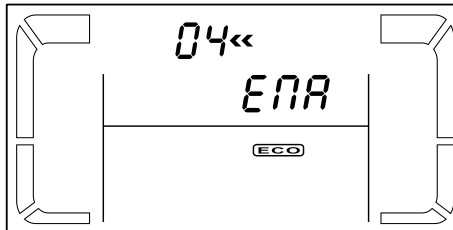

Parameter 3: Enable or disable ECO function. You may choose the following two options.

ENA: ECO mode enable

DIS: ECO mode disable (Default)

- **05: ECO voltage range setting**

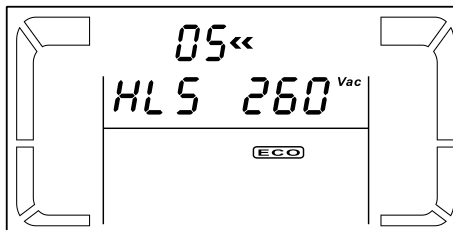

Parameter 2 & 3: Set the acceptable high voltage point and low voltage point for ECO mode by pressing the Down key or Up key.

HLS: High loss voltage in ECO mode in parameter 2.

For 200/208/220/230/240 VAC models, the setting range in parameter 3 is from +7V to +24V of the nominal voltage. (Default: +12V)

LLS: Low loss voltage in ECO mode in parameter 2.

For 200/208/220/230/240 VAC models, the setting range in parameter 3 is from -7V to -24V of the nominal voltage. (Default: -12V)

- **06: Bypass enable/ disable when the UPS is off**

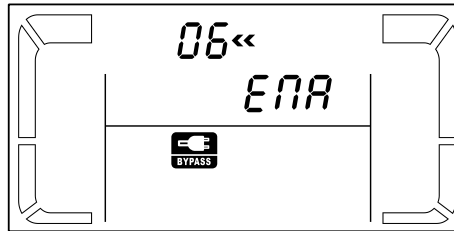

Parameter 3: Enable or disable bypass function. You may choose the following two options.

ENA: Bypass enable

DIS: Bypass disable (Default)

- **07: Bypass voltage range setting**

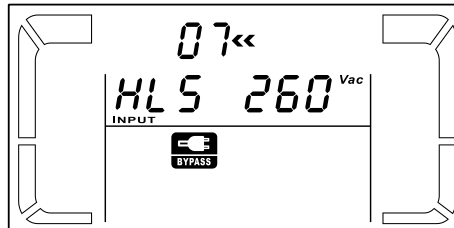

Parameter 2 & 3: Set the acceptable high voltage point and acceptable low voltage point for bypass mode by pressing the Down key or Up key.

HLS: Bypass high voltage point

For 200/208/220/230/240 VAC models:

230-264: setting the high voltage point in parameter 3 from 230Vac to 264Vac. (Default: 264Vac)

LLS: Bypass low voltage point

For 200/208/220/230/240 VAC models:

170-220: setting the low voltage point in parameter 3 from 170Vac to 220Vac. (Default: 170Vac)

- **08: Autonomy limitation setting**

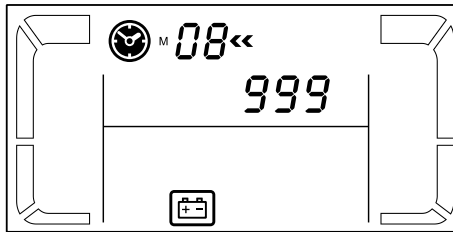

Parameter 3: Set up backup time in battery mode for general outlets.

0~999: setting the backup time in minutes from 0~999 for general outlets in battery mode.

0: When setting as “0”, the backup time will be only 10 seconds.

999: When setting as “999”, the backup time setting will be disabled (Default).

- **09: Total battery AH**

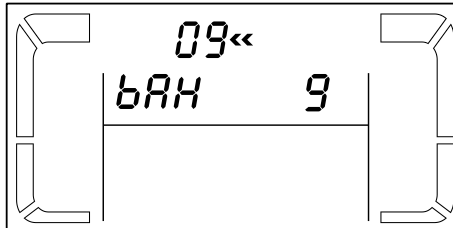

Parameter 3: Set up total battery AH value of the UPS. (unit: AH)

7-999: setting the total battery capacity from 7 to 999. Please set up this figure if external battery pack is connected.

If the UPS is standard runtime model, the default setting is 9AH.

If the UPS is extended runtime model, the default setting is 65AH.

- **00: Exit Setting**

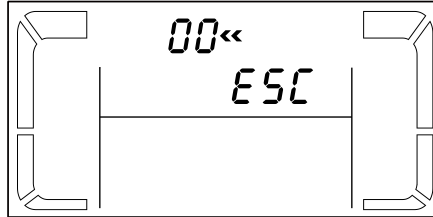

Exit the setting mode.

3.6 Operating Mode Description

- **Online Mode**

When the input voltage is within acceptable range, the UPS will provide pure and stable AC power to output. The UPS will also charge the battery in online mode.

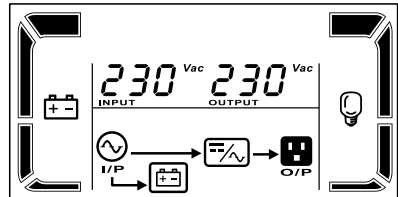

- **ECO Mode**

Energy saving mode:

When the input voltage is within voltage regulation range, the UPS will run in bypass mode to supply power to output for energy saving.

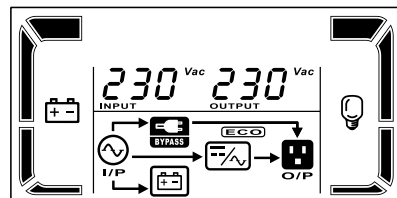

- **Frequency Converter Mode**

When the input frequency is within 40 Hz to 70 Hz, the UPS can be set at a constant output frequency, 50 Hz or 60 Hz. The UPS will still charge batteries under this mode.

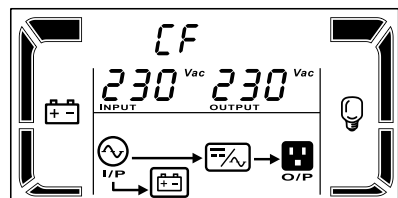

- **Battery Mode**

When the input voltage is beyond the acceptable range or power failure occurs, the UPS will backup power from batteries and the alarm is sounding every 4 seconds.

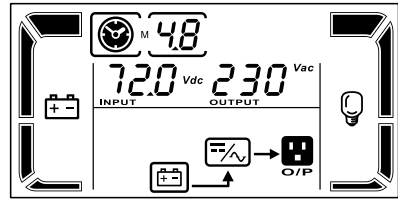

- **Bypass Mode**

When the input voltage is within acceptable range but the UPS is overloaded, the UPS will enter bypass mode or bypass mode can be set via the front panel. The alarm is sounding every 10 seconds.

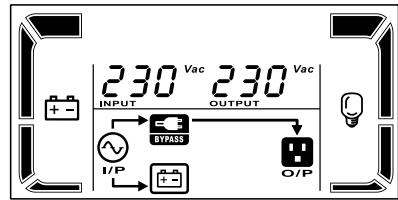

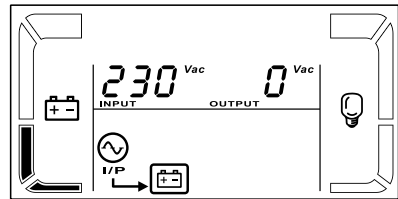

- **Standby Mode**

The UPS is powered off and there is no output, but the batteries can still be charged.























3.7 Faults Reference Code

Fault Event	Fault Code	Icon
Bus start fail	01	X
Bus over	02	X
Bus under	03	X
Bus unbalance	04	X
Inverter soft start failure	11	X
Inverter voltage high	12	X
Inverter voltage Low	13	X
Inverter output short	14	SHORT





Fault Event	Fault Code	Icon
Battery voltage too high	27	
Battery voltage too low	28	
Over temperature	41	x
Overload	43	
Charger failure	45	x



3.8 Warning Indicator

Warning	Icon (flashing)	Alarm
Low battery	 	Sounding every second
Overload	 	Sounding twice every second
Battery is not connected	 	Sounding every second
Over charge	 	Sounding every second
Over temperature	 	Sounding every second
Charger failure	 	Sounding every second
Battery fault	 	Sounding every second
Out of bypass voltage range	 	Sounding every second
Bypass frequency unstable	 	Sounding every second
EEPROM error	 	Sounding every second

Chapter 4 : Troubleshooting

If the UPS system does not operate correctly, please solve the problem by using the table below.

Symptom	Possible Cause	Remedy
No indication and alarm even though the mains is normal.	The AC input power is not connected well.	Check if the input power cord firmly connected to the mains.
	The AC input is connected to the UPS output.	Plug the AC input power cord to the AC input correctly.
The icons  and  are flashing on the LCD display and the alarm is sounding every second.	The external or internal batteries are incorrectly connected.	Check if all batteries are connected well.
Fault code is shown as 27 or 28 and the icon  is lighting on the LCD display and the alarm is continuously sounding.	Battery voltage is too high/low or the charger is fault.	Contact your dealer.
The icons  and  are flashing on the LCD display and the alarm is sounding twice every second.	The UPS is overloaded.	Remove excess loads from the UPS output.
	The UPS is overloaded. Devices connected to the UPS are fed directly by the electrical network via the bypass.	Remove excess loads from the UPS output.
	After repetitive overloads, the UPS is locked in bypass mode. Connected devices are fed directly by the mains.	Remove excess loads from the UPS output first. Then shut down the UPS and restart it.

Symptom	Possible Cause	Remedy
Fault code is shown as 43 and the icon  is lighting on the LCD display and the alarm is continuously sounding.	The UPS shuts down automatically because of overload at the UPS output.	Remove excess loads from the UPS output and restart it.
Fault code is shown as 14 and the icon  is lighting on the LCD display and the alarm is continuously sounding.	The UPS shuts down automatically because short circuit occurs on the UPS output.	Check output wiring and if connected devices are in short circuit status.
Fault code is shown as 01, 02, 03, 04, 11, 12, 13, 41 or 45 on the LCD display and the alarm is continuously sounding.	An UPS internal fault has occurred. There are two possible results: <ol style="list-style-type: none"> 1. The load is still supplied, but directly from AC power via bypass. 2. The load is no longer supplied by the power. 	Contact your dealer.
Battery backup time is shorter than nominal value.	Batteries are not fully charged.	Charge the batteries for at least 5 hours and then check capacity. If the problem still persists, consult your dealer.
	Batteries are damaged.	Contact your dealer to replace the batteries.

Chapter 5 : Storage and Maintenance

- **Operation**

The UPS system contains no user-serviceable parts. If the battery service life (3~5 years at 25°C ambient temperature) has been exceeded, the batteries must be replaced. In this case, please contact your dealer.



Be sure to deliver the spent battery to a recycling facility or ship it to your dealer in the replacement battery packing material.

- **Storage**

Before storing, charge the UPS 5 hours. Store the UPS covered and upright in a cool, dry location. During storage, recharge the battery in accordance with the following table:

Storage Temperature	Recharge Frequency	Charging Duration
-25°C ~ 40°C	Every 3 months	1 ~ 2 hours
40°C ~ 45°C	Every 2 months	1 ~ 2 hours

Chapter 6 : Technical Specifications

Model	1K	2K	3K
Capacity	1000 VA / 800 W	2000 VA / 1600 W	3000 VA / 2400 W
Input			
Voltage Range	110-300Vac*		
Frequency Range	40Hz ~ 70Hz		
Phase	Single phase with ground		
Power Factor	≥ 0.99 @ nominal voltage (Input Voltage)		
Output			
Nominal voltage	200**/208**/220/230/240 Vac		
Voltage Regulation	$\pm 1\%$ (Batt. Mode)		
Frequency Range	47 ~ 53 Hz or 57 ~ 63 Hz (Synchronized Range)		
Frequency Range (Batt. Mode)	50Hz \pm 0.25Hz or 60Hz \pm 0.3Hz		
Overload	Ambient Temp. <35°C 105% ~ 110%: The UPS shuts down after 10 minutes in battery mode or transfers to bypass when the utility is normal. 110% ~ 130%: The UPS shuts down after 1 minute in battery mode or transfers to bypass when the utility is normal. >130%: The UPS shuts down after 3 seconds in battery mode or transfers to bypass when the utility is normal.		
Current Crest Ratio	3:1		
Harmonic Distortion	$\leq 3\%$ THD (linear load); $\leq 6\%$ THD (non-linear load)		
Waveform (Batt. Mode)	Pure Sinewave		
Efficiency			
AC Mode	88%	89%	90%

Model	1K	2K	3K
Battery			
Battery Type	12 V / 9 AH	12 V / 9 AH	12 V / 9 AH
Numbers	Standard Runtime Model: 2/4/6 ; Extended Runtime Model: 3/6/6		
Recharge Time	Standard Runtime Model: 4 hours recover to 90% capacity (Typical) ; Extended Runtime Model: Depends on the batteries attached		
Charging Current	Standard Runtime Model: 1A ; Extended Runtime model: 1/2/4/6A		
External Battery Connector	Standard Runtime Model: N/A ; Extended Runtime Model: 1pc		
Physical			
Standard Runtime Model			
Dimensions (D x W x H)(mm)	282 X 145 X 220	504 X 145 X 220	421 X 190 X 318
Net Weight (kg)	9.0	16.5	25
Extended Runtime Model			
Dimensions (D x W x H)(mm)	282 x 145 x 220	397x 145 x 220	
Net Weight (kg)	4.4	7.3	7.8
Environment			
Operation Humidity	20-90 % RH @ 0- 40°C (non-condensing)		
Noise Level	Less than 50dBA @ 1 Meter		
Communication			
Interface	RS-232, USB, Mini-slot		



NOTE:

1. * At 110~160Vac, linear de-rating between 60 ~ 100% load is required.
2. **De-rate capacity to 80% of capacity when the output voltage is adjusted to 200VAC or 208VAC
3. Please refer to the rating label for the safety rating.
4. All specifications are subject to change without prior notice.

Chapter 7 : Warranty

Seller warrants this product, if used in accordance with all applicable instructions, to be free from original defects in material and workmanship within the warranty period. If the product has any failure problem within the warranty period, Seller will repair or replace the product at its sole discretion according to the failure situation.

This warranty does not apply to normal wear or to damage resulting from improper installation, operation, usage, maintenance or irresistible force (i.e. war, fire, natural disaster, etc.), and this warranty also expressly excludes all incidental and consequential damages.

Maintenance service for a fee is provided for any damage out of the warranty period. If any maintenance is required, please directly contact the supplier or Seller.

**WARNING:**

The individual user should take care to determine prior to use whether the environment and the load characteristic are suitable, adequate or safe for the installation and the usage of this product. The User Manual must be carefully followed. Seller makes no representation or warranty as to the suitability or fitness of this product for any specific application.

